



# AIRSEP 290

The AIRSEP 290 is a two-row bunker harvester with fully hydraulic drives, patented AirSep separator and a bunker with a capacity of 9 tonnes as standard.



# AIRSEP 290

At the Agritechnica 2013, GRIMME and SPUDNIK, which is also part of the GRIMME Group, presented the revolutionary AirSep separator, which was awarded the highest award of the German Agricultural Society (DLG) - a DLG Gold medal. This separator, which is particularly suitable for stony soils, has undergone extensive further development in recent years and has been integrated into an independent new machine series - called AIRSEP 290.

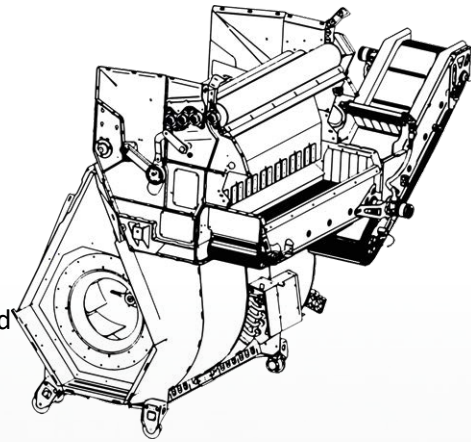

## New swing frame

The new geometry of the swing frame prevents possible haulm build-up while at the same time saving weight. Recesses are provided for the standard stainless steel plates, which gives the operator a visual of when the plate needs changing. All rollers are also easily accessible and replaceable.



## Depth control

In addition to the standard ridge relief, the AIRSEP 290 can be optionally equipped with the TerraTronic depth control, which can be used for automatic ridge relief or ridge pressure regulation. Alternatively the machine can be equipped with TerraDisc (a special intake that does not require diabolos). In this case the automatic depth control can be achieved by scanning the ridge crown using two skids. TerraDisc is therefore particularly suitable for heavy soils.



## Completely hydraulic drives

Thanks to the standard, completely hydraulic drive-system, all main webs, including the optionally available intake web and the separators, can be adjusted in km/h regardless of the tractor's PTO speed. All main webs can also be reversed individually. The avoidance of mechanical drive components also improves accessibility for cleaning and maintenance work.

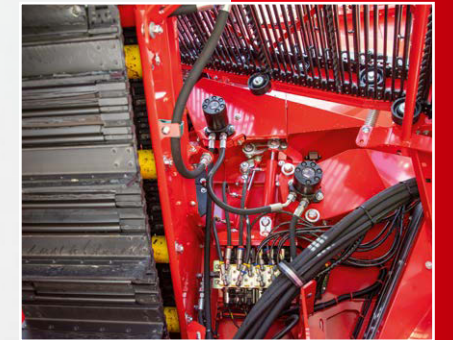

## Intake web

The additional, upstream fitted intake web leads to an additional drop step in the crop flow and thus additional cleaning. It is particularly suitable for heavy and/or wet harvest conditions and can be adjusted in a range of 1-9 km/h independently of the other main webs.



## Transfer onto the AirSep-Separator

Hydraulically driven plain rollers, in combination with a crop guiding deflector, ensure an even and defined transfer from the second main web onto the AirSep separator.

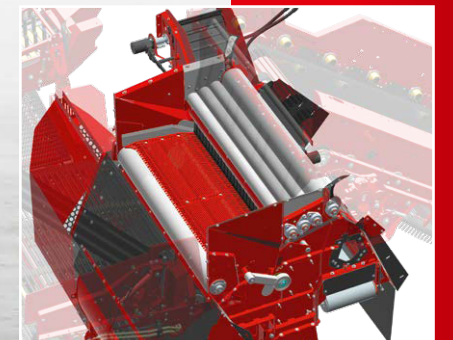





## When Formula 1 technology meets potato technology

The AirSep is a pneumatic separator that separates the components of the product flow that have a higher density than the potatoes. An airstream keeps the crop in a floating position and gently transfers it from the separator. The entire machine concept was developed around the AirSep separator in order to be able to separate trash and stones from the crop flow as early as possible. This minimises the risk of damaged crop!

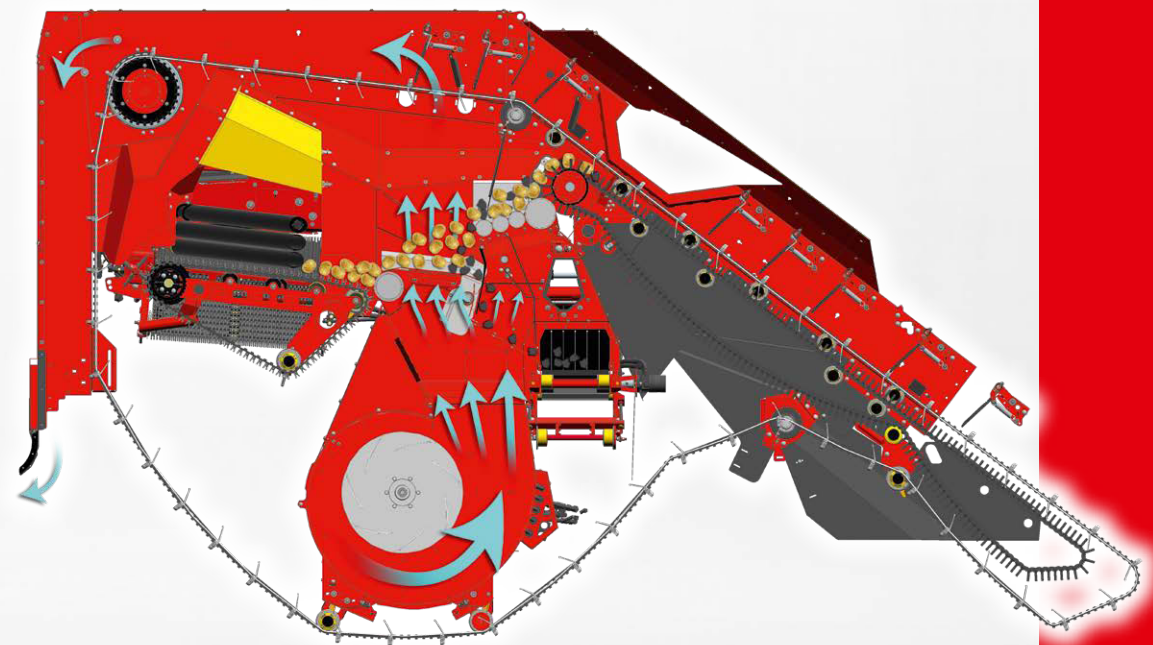

During the further development of the AIRSEP 290, the AirSep separator was optimised with the help of a "CFD simulation". The calculation method for aerodynamic behaviour known from the development of Formula 1 racing cars was used to design an energy-efficient system within the available installation space. As well as the actual blower, the entire housing around the deviner web was adapted to optimise the airflow. Among other things, the simulation utilised the so-called 'Coanda effect' to deflect the outgoing airflow to the rear.







### ClodSep separator

The ClodSep separator is equipped with two double-row finger scraper belts. In conjunction with the AirSep, it is primarily used to separate dry clods. Trash and impurities can be inspected a second time when they pass the trash conveyor. The optional V-shaped finger arrangement (patent pending) increases throughput.



### Perfect separation result

In addition to the automatic speed adjustment of the hedgehog-web-separators ("Speedtronic-Sep"), with "Speedtronic-Web" the main web speed can be controlled fully automatically, load-dependently and in relation to the harvest speed, thus relieving the driver and protecting the crop.



### Impressive results

The result is a product flow that is free of stones and damp clods. After the AirSep, these are discharged onto the trash web and are then fed into a stone box which can be unloaded at the edge of the field.



### Improved comfort for the picking staff

Depending on the equipment variant, the machine comes with height-adjustable platform raises, stuffings, waterproof storage boxes, a hand wash tank and various cleaning spades. An extension ladder is included as standard and can be attached to the machine at various points.

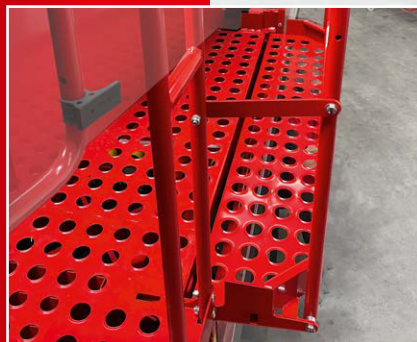

### Extendable platform

Large platforms on both sides of the picking table for the picking staff and discharge chutes are provided as standard. The platform on the left-hand side of the machine can also be extended so that up to 5 people can work comfortably at the picking table.







### Dust-protected

The tarpaulin above the deviner web reduces dust and thus increases comfort for the picking staff.



### Stone box

Below the left platform is the boulder box with a capacity of approx. 1 m<sup>3</sup> and a discharge conveyor. Filling takes place via favourably positioned chutes and the trash web. The boulder box is unloaded hydraulically outside the machine contour. Operation can be carried out from the tractor's cab via operator terminal.



### 7.5 t NonstopBunker

In addition to the 9-tonne standard bunker, a 7.5-tonne NonstopBunker is also available. The patented, completely circulating bunker floor enables fast, gentle overloading without stopping during harvesting. Even boxes, standing in the second row on a trailer alongside, can be easily reached thanks to the large overloading width.



### Bunker floor with canvas and continuously padded bunker strips

The bunker floor made of canvas with its pockets ensures a good conveying effect. In addition to the low discharge height of the bunker filling elevator, the padding of all bunker strips ensures additional crop protection.



### Mapping of gross crop weight

The system records yield differences within the field and documents the crop yields on a site-specific basis. Problem areas within the plot can be localized and logistics planning can be optimized. All measured values can be saved in ISO-XML format and transmitted using a USB-stick or wirelessly via the "agrirouter".







### TriSys - the GRIMME tricycle chassis

The TriSys chassis offers up to 65% more contact area (footprint) compared to a standard harvester. All wheels are steered and thus offer a considerably stabilized chassis of the machine. The optional radial tires up to a size of 850/50 R30.5 enable a ground-protective driving on the field.

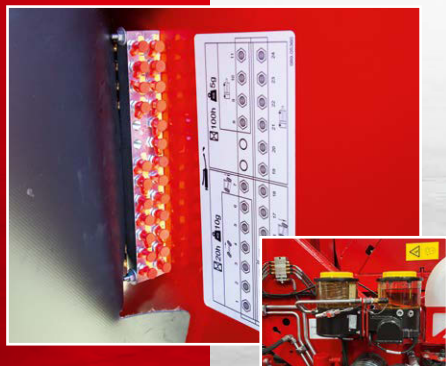

### Automatic greasing system

The central lubrication rails are fitted as standard and bundle lubrication points. A clear indication of the lubrication quantity and interval makes maintenance work easier. With the optional central lubrication system, all lubrication points on the drawbar, bunker and axle are lubricated automatically.

### "See - What you want and How you want it"

Thanks to the SmartView video system with 8 cameras, all relevant functions remain permanently in view. With many functions, such as live slow motion, the large display can be freely customized. All-round visibility in the dark is also significantly improved by the new LED ambient lighting.



### Clearly arranged and easy to operate

Operation is convenient and is done via ISOBUS as standard. The GRIMME Digital Interface (GDI) provides the operator with an ideal overview of the machine parameters to be set. All taskdata, machine- and location parameters can be transmitted wireless to the end customer portal myGRIMME, or via "agrirouter" to the farm's own Farm Management Information System (FMIS).





# GRIMME regardless of brand used and more

---

## Sell your used machinery

- > Get your non-binding offer
- > Payment before pickup on site possible
- > Simple sales process
- > Pick up of your machine free of charge



Receive a non-binding offer for your used potato-, beet- and vegetable technology from GRIMME or other well-known manufacturers.

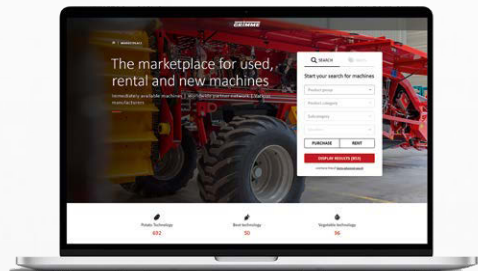

## Digital. Simple. Connected - myGRIMME

---



myGRIMME is your gateway to the digital world of GRIMME. With your account, you always have your virtual machine file with all digital services and information with you in real time. In addition, your machine tasks are automatically documented and analysed clearly. Furthermore, with the webshop you have the possibility to order spare parts online. myGRIMME can be used on any internet-enabled device and is free of charge for you.



[my.grimme.com](http://my.grimme.com)